

Order Code: R006
HV-6 - Rotary Table
152mm



On Special - Ends 30th June 2017	
ex GST	inc GST
\$300.00	\$330.00
\$254.55	\$280.00



ORDER CODE	R006
Model	HV-6
Size	152mm
A1	78mm
D	150mm
H	80mm
H1	100mm
A	200mm
B	160mm
e	11mm
g	15mm
Number of T-Slots	3
T-Slot Size	11mm
Taper In Centre	2MT
Weight	14kg

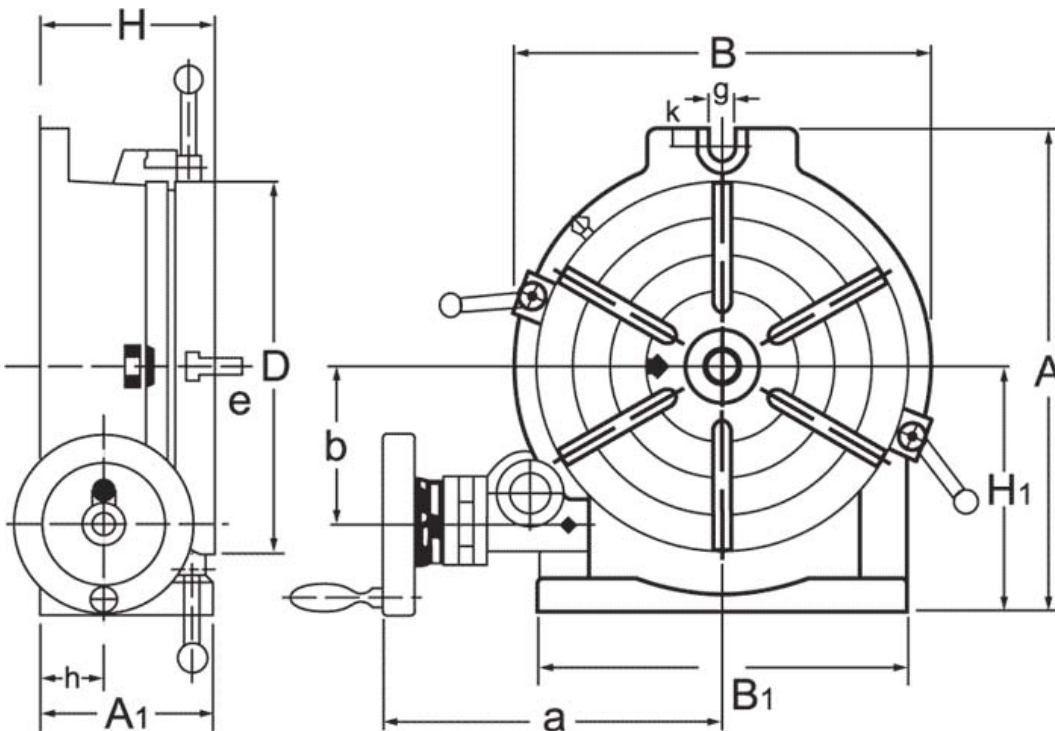

Description

Manufactured in Taiwan

The Vertex Rotary Table has been designed to be used where a precision work positioning device is required. It allows the operator to mill or drill components at exact intervals around a fixed axis. Additional indexing plates can be fitted to allow the Vertex Rotary Table to be used as a Dividing Head. The Vertex Rotary Table can be used in both the horizontal or vertical plane.

Features







- The Vertex Rotary Table is manufactured from high-density Meehanite cast iron with ground surface areas on the table and body to ensure smooth rotation
- Critical wear parts are hand finished for ultra precision
- All tables are tested for accuracy using 'Heidenhain' electronic equipment to ensure continuing quality
- Worm is hardened and precision ground, with a ratio of 90:1
- Table is graduated to a full 360° so one turn of the handle moves the table 4°
- The collar on the handle is graduated with a vernier scale, readings down to 10 seconds are possible

Specific Features



Vertical View

Recommended Accessories

		Code	ex GST	inc GST
	DP-1 Dividing Plate Suits HV-4 & HV-6 Rotary Tables	R016	\$101.82	\$112.00
	TS-1 Tailstock 110-80mm	R013	\$101.82	\$112.00
	K11 SERIES 3 Jaw Self Centring Lathe Chuck 130mm	C280	\$152.73	\$168.00
	Clamp Kit Tee Nuts 10mm	C085	\$10.91	\$12.00
	TM-8 Mini Clamp Kit 10 piece - Workshop Series Suits 10mm Table Slot	C0948	\$25.45	\$28.00
	HF-10 Clamp Kit 58 piece - Workshop Series Suits 10mm Table Slot	C0945	\$76.36	\$84.00